

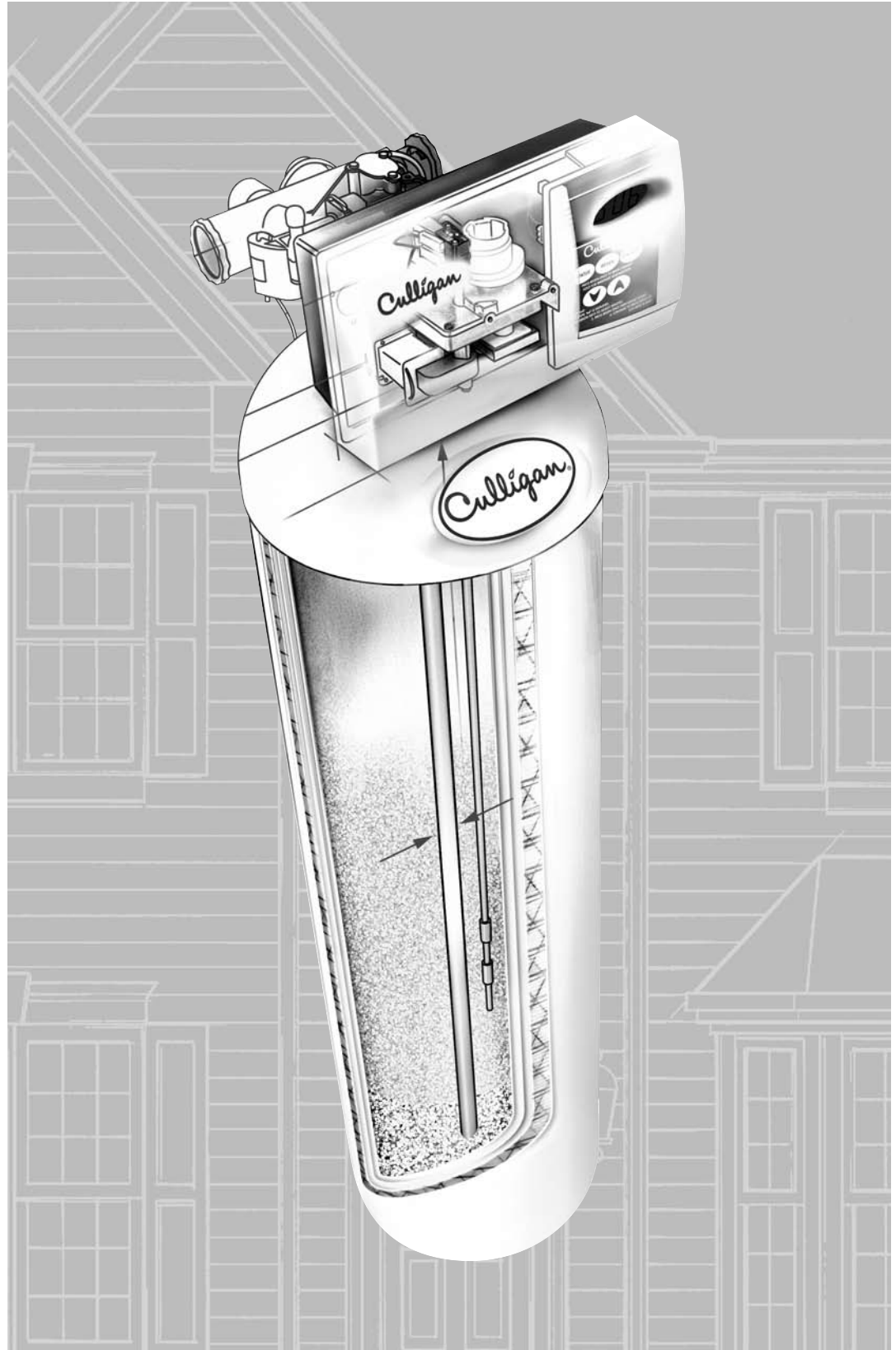

Culligan®

**Culligan
Gold Series™
Automatic
Water Filter
Owners Guide**





Thank You

And Welcome To Your New World Of Better Living With Culligan Water.

The Culligan Gold Series™ Cullar® filter has been tested and certified by WQA against WQA S-200 for the effective reduction of chlorine taste and odor up to 120,000 gallons for the 9" filter and 180,000 gallons for the 10" filter.

The Culligan Gold Series™ Cullneu® filter has been tested and certified by WQA against WQA S-200 for neutralization up to 14,500 gallons for the 9" Cullneu filter and 21,750 gallons for the 10" Cullneu filter as verified and substantiated by test data.

The Culligan Gold Series™ Filtr-Clear® 9 Model has been tested and certified by WQA against WQA S-200 for Class V (>30µm to <50µm) particulate reductions as verified and substantiated by test data. The Culligan Gold Series Filtr-Clear 10" has not been certified by WQA.



For installations in Massachusetts, Massachusetts Plumbing Code 248 CMR shall be adhered to. Consult your licensed plumber for installation of this system. This system and its installation must comply with state and local regulations.

Hardness sample kits are available through your local Culligan Dealer.

If this is your first experience having soft, conditioned water in your home, you'll be amazed at the marvelous difference it makes. We promise that you'll never want to be without it again.

Congratulations, too, on selecting one of the "first family" of water filters in the prestigious Culligan Gold Series. With Culligan's many years of knowledge and experience in water treatment, you can be confident that the model you selected has been designed and engineered to provide years of service with a minimum of care and attention.

Some localities have corrosive water. A water softener cannot correct this problem and so its printed warranty disclaims liability for corrosion of plumbing lines, fixtures or appliances. If you suspect corrosion, your Culligan Dealer has equipment to control the problem.

Sodium Information: Water softeners using sodium chloride for regeneration add sodium to the water. Persons who are on sodium restricted diets should consider the added sodium as part of their overall sodium intake.

Attention Culligan Customer:

The installation, service and maintenance of this equipment should be rendered by a qualified and trained service technician. Your local independently operated Culligan dealer employs trained service and maintenance personnel who are experienced in the installation, function and repair of Culligan equipment. This publication is written specifically for these individuals and is intended for their use.

We encourage Culligan users to learn about Culligan products, but we believe that product knowledge is best obtained by consulting with your Culligan dealer. Untrained individuals who use this manual assume the risk of any resulting property damage or personal injury.

Products manufactured and marketed by Culligan International Company (Culligan) and its affiliates are protected by patents issued or pending in the United States and other countries. Culligan reserves the right to change the specifications referred to in this literature at any time, without prior Note. Culligan, Culligan Gold Series, Cullar, Filtr-Clear, Cullneu, Accusoft and Culligan Man are trademarks of Culligan International Company or its affiliates.



Performance Data Sheets are included in this manual for various Culligan Gold Series™ Softener models. Refer to the Performance Data Sheet for your specific softener, as there are slight differences between the models. The softener warranty is located on page 18 of this Owner's Guide.

Table of Contents

| | |
|--|----|
| Specifications | 4 |
| Introduction | 5 |
| Familiarization | 6 |
| Programming | 7 |
| Care and Cleaning Of Your Water Conditioner | 11 |
| Recommended Preventative Maintenance | 11 |
| Things To Check Before You Call Service | 12 |
| Error Codes | 13 |
| Culligan Gold Series Cullar Filter 9" and 10" PDS | 14 |
| Culligan Gold Series Cullneu Filter 9" and 10" PDS | 15 |
| Culligan Gold Series Filtr-Clear 9" PDS | 16 |
| Records and Data | 17 |
| Warranty | 18 |



Specifications

| | 9-Inch | 10-Inch |
|--|-------------------------------|-------------------------------|
| General | | |
| Mineral Tank Size | 9x48 in. (229x1,219mm) | 10x54 in. (254x1,372mm) |
| Control | Hi-Flo Power Valve | Hi-Flo Power Valve |
| Timer | Electronic | Electronic |
| Temperature Limits | 33-120°F (1-50°C) | 33-120°F (1-50°C) |
| Water Pressure Limits | 20-120 psi (140-830kPa) | 20-120 psi (140-830kPa) |
| Water Pressure Limits (Canada) | 20-90 psi (140-620kPa) | 20-90 psi (140-620kPa) |
| Electrical Requirements | 24V/50-60 Hz | 24V/50-60 Hz |
| Electrical Power Consumption, Min./Max. | 3 Watts/35 Watts | 3 Watts/35 Watts |
| Overall Height | 54 in. (1,372 mm) | 60 in. (1,524 mm) |
| Filtr-Clear^{®5} | | |
| Rated Service Flow @ Pressure Drop | 9.0 gpm @ 8 psi | 12.0 gpm @ 15 psi |
| Minimum Practical Filtration Size | 30 microns | 15 microns |
| Maximum Particulate Matter | 150 NTU | 150 NTU |
| Maximum Suspended Solids | 150 mg/L | 150 mg/L |
| Drain Flow, Maximum ¹ | 4.5 gpm | 7.0 gpm |
| pH Limitation | 6.0 - 9.5 | 6.0 - 9.5 |
| Recharge Time ² | 30 min. | 30 min. |
| Recharge Water Consumption, Av. ³ | 90 gal. | 140 gal. |
| Freeboard ⁴ | 20 ± 1.5 inches | 19 ± 1.5 inches |
| Cullar[®] | | |
| Rated Service Flow @ Pressure Drop | 4.0 gpm @ 3.0 psi | 6.0 gpm @ 6.0 psi |
| Drain Flow, Maximum ¹ | 3.5 gpm | 5.5 gpm |
| pH Limitation | 5.0 - 11.0 | 5.0 - 11.0 |
| Recharge Time ² | 30 min. | 30 min. |
| Recharge Water Consumption, Av. ³ | 40 gal. | 110 gal. |
| Cullar Media Volume | 0.75 cu. ft. | 1.5 cu. ft. |
| Cullsan [®] Underbedding Media Amount | 10 lbs. (.1 ft ³) | 20 lbs. (.2 ft ³) |
| Freeboard ⁴ | 22 ± 1.5 inches | 24 ± 1.5 inches |
| Rated Capacity | 120,000 gallons | 180,000 gallons |
| Cullneu[®] | | |
| Rated Service Flow @ Pressure Drop | 4.0 gpm @ 2.0 psi | 6.0 gpm @ 5.0 psi |
| Drain Flow, Maximum ¹ | 3.5 gpm | 5.5 gpm |
| pH Limitation* | 5.2 to 6.8 | 5.2 to 6.8 |
| Recharge Time ² | 30 min. | 30 min. |
| Recharge Water Consumption, Av. ³ | 70 gal. | 110 gal. |
| Cullneu Media Volume | 1.1 cu. ft. | 1.6 cu. ft. |
| Freeboard ⁴ | 13 ± 1.5 inches | 18 ± 1.5 inches |
| Rated Capacity | 14,500 gallons | 21,750 gallons |

1 Backwash at 120 psi (830 kPa).

2 Factory Settings.

3 Factory Settings and 120 psi line pressure.

4 Measured from top of media surface to top surface of tank threads (backwashed and drained).

5 The Filtr-Clear 10" filter data has not been certified by WQA.

* **Note:** Under dynamic conditions, it may be necessary to mix five parts Cullneu with one part Cullneu C to effectively raise the pH.



Filtr-Clear®

The Filtr-Clear Automatic Water Filter is capable of reducing particulate matter down to 30 microns particle size. It will not remove color, organics, colloidal turbidity or dissolved solids. Some applications follow:

- Reduction of suspended matters in any water system.
- Reduction of particulate matter, such as clay, mud, etc.
- Prefiltration of oxidized iron ahead of an automatic or manual softener.
- Reduction of light sand.

Note: *If sands cannot be reduced from the Filtr-Clear tank during backwashing, a sand trap should be installed.*

- After the retention tank when a Cul-Clear® system is used to correct hydrogen sulfide or colloidal suspension problems.

The quality and number of gallons filtered water between backwashes will depend upon the amount, type, and size of the particulate matter being filtered. If a water sample is sent to our laboratory, where application of a Filtr-Clear unit is contemplated, write "Filtr-Clear Analysis" on the sample tag. Send an additional sample of water for a standard water analysis. The laboratory will test for Nephelometric Turbidity Units (NTU) and suspended solids (mg/L). The sample will also be filtered through 10 micron filter paper and NTU run on a filtered sample. If the NTU of the raw water exceeds 150, suspended solids exceed 150 mg/L or the filtered water through the 10 micron filter paper is of an unacceptable quality, a Filtr-Clear filter may not be applicable. As a guide, the U.S. Public Health Drinking Water standards states the turbidity should not exceed 1 NTU. The exact number of gallons filtered between backwashes cannot be given because of many variables.

Cullar® Filter

Gold Water Filter with Cullar Media will reduce chlorine taste and odor and other common bad tastes and odors, and will also reduce most objectional organic colors. It will not remove hydrogen sulfide. It is important to note that whenever the cause of an objectionable taste or odor has not been established, Health Authorities should determine if water is safe to drink. If bacterial contamination is present, a Cul-Clear® system is indicated. Do not use with water that is microbiologically unsafe or of unknown quality without adequate disinfection before or after the system.

Cullneu® Filter

Gold Water Filter with Cullneu Media will neutralize slightly acid water (pH (5.2 > 6.8)) and thus help to prevent unsightly brown or green stains due to corrosion of household plumbing. If the pH is from 5 to 6, one part of Cullneu C media should be mixed with 5 parts of Cullneu media to provide additional neutralizing capability. If the water to be treated has a pH less than 5, a high hardness, or a high carbon dioxide level, Cullneu may not be applicable; a solution feeder should be used. Since Cullneu adds hardness, it should be used prior to a softener.

In order to size and apply the equipment correctly, a complete analysis of the water supply should be obtained. This can best be accomplished by contacting your local Culligan dealer, who will be able to test the water supply right at the site, or arrange to have one or more water samples sent to the Culligan laboratory for a more detailed analysis.

Introduction



Familiarization

Modes of Operation

Manual Regeneration

Pressing and holding the regen button for 3 seconds will initiate an immediate regeneration. The beeper is to give one beep at the start of manual regeneration (when the motor starts to turn). In delay mode, pressing and releasing the regen button will light the regen icon for regeneration to occur at the set delay time. Pressing and releasing the regen button again will turn off the regen icon.

Power Loss

The AccuSoft® circuit board is equipped with a Hi-Cap Capacitor and EEPROM memory chip. The capacitor is capable of maintaining the time, for at least one day, in the event of a power outage. The EEPROM ensures that the individual programming parameters of your softener are not lost.

If the power outage lasts long enough to drain the Hi-Cap Capacitor, the control will flash "12:00 PM" when power is returned to the control. The unit will continue to keep time from the moment power is restored, and will initiate a full regeneration at the preset regeneration time. The time of day will need to be reset in order to return the regeneration to its preset time.

If you live in an area where power outages occur with a regular frequency, a battery backup option is available for ensuring that the time of day is properly maintained. Contact your Culligan Dealer for more information.

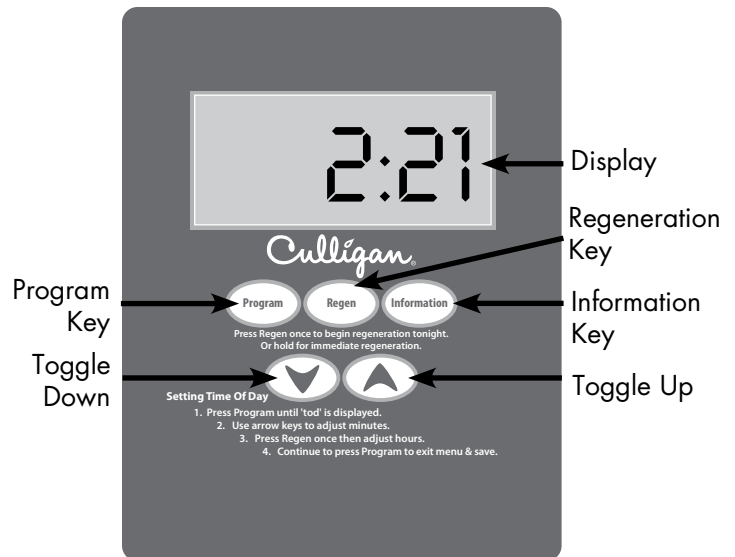

| Display | Back-lit LCD display. |
|------------------|--|
| Program Key | Depress to enter and move through the programming steps. |
| Regeneration Key | Press and hold the key for three (3) seconds to initiate an immediate regeneration. When pressed during programming the time of day, this key will allow the user to toggle between the hours and minutes setting of timing program segments. |
| Information Key | Each time depressed, the Information key will display statistical information such a flow rate, time of day. Use with the Toggle Down key to display other statistical information. |
| Toggle Down Key | In the programming mode this key will move the user through the programming function in a descending mode. If depressed for greater than three seconds, the rate at which the display scrolls through data will increase. |
| Toggle Up Key | In the programming mode this key will move the user through the programming function in an ascending mode. If depressed for greater than five seconds, the rate at which the display scrolls through the data will increase. This key will also allow the user to manually step through the cycles of regeneration. |



Programming

The Culligan® AccuSoft® Plus circuit board controls all of the filter functions. These settings are programmed at the time of installation. The following is a list of all the microprocessor functions, in the event that any of the settings need to be adjusted.

| REGEN EFFICIENCY MODE | TODAY'S AVG DAILY WATER USAGE | SOFTWATER REMAINING |
|--------------------------|----------------------------------|--|
| 00000 | 00000 | 00 PM |
| 00000 | 00000 | 00 % |
| 00000 | 00000 | 00 MINS |
| 00000 | 00000 | 00 AM |
| BACKWASH GALLONS | BRINE RINSE LITERS | FAST RINSE / REFILL FLOW RATE GPM LPM |

1. **Beeper Setting** - This setting is used to turn the beeper on or off for each key press actuation. The display will show "bEEP X" where X is either "Y" or "N". The "Y" or "N" will be toggled with the "+" and "-" keys. Setting the Beep option to "N" will only disable the beeper for key press actuation. The beeper will still be active for error and alarm codes.

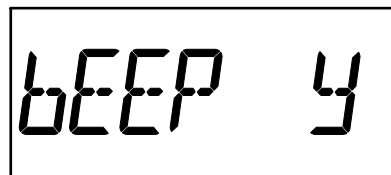

Pressing the "Status" key will save the setting and move to the next programming step.

2. **Time of Day** - This setting is used to program the current time of day. When in this step the display will first show "tod" for two seconds.



After "tod" is displayed, "12:00 PM" will display (or the current set time if already programmed) and the minutes will flash. The minutes are adjusted with the "+" or "-" key until the correct value is displayed.



Press the "Regen" key to flash the hours. Adjust with the "+" or "-" key until the correct time is displayed.

Pressing the "Status" key will move to the next programming step. Pressing "Regen" will move back to the minutes adjust.

3. **Time of Regeneration** - This setting is used to program the time at which a regeneration is to occur in the delay mode, or in immediate mode with time clock backup on. The display will first show "tor" for two seconds.



After "tor" is shown the display will then show the default of 2:00 AM (or the current programmed time of regeneration if already set). The time can be adjusted in 30 minute increments by pressing the "+" or "-" keys.



Pressing the "Status" key will save the setting and move to the next programming step.



Programming (cont.)

- 4. Backwash Time** - This setting is used to program the backwash. The time of the cycle is kept in minutes. The display will show the "BACKWASH" and "MINS" icons and the cycle time in the right most digits. Adjust the value with the "+" or "-" keys.

Pressing the "Status" key will save the setting and move to the next programming step.



- 5. Pause Cycle** - This setting is used to set the time in minutes for brine drain/slow rinse cycle. The display will show the "BRINE RINSE" and "MINS" icons and the cycle time in the right most digits. Adjust the value with the "+" or "-" keys.

Pressing the "Status" key will save the setting and move to the next programming step.



- 6. Fast Rinse** - This setting is used to set the time in minutes for the fast rinse cycle. The display will show the "FAST RINSE", "/", "REFILL" and "MINS" icons and the cycle time in the right most digits. Adjust the value with the "+" or "-" keys. Pressing the "Status" key will save the setting and move to the next programming step.



- 7. Day(s) of Week**

Regeneration -

The following optional days of the week setting will be available to trigger regeneration. The display will show "dAYoWK" for 2 seconds followed by "NO". The "+" or "-" key will toggle "yes" or "no" (default is NO). A "yes" response will indicate that the control is to perform a regeneration on specific days of the week.

Pressing "STATUS" will save and advance to the next step. If "NO" was chosen, then the control will only initiate regenerations based upon the interval (in number of days) and the display will show as shown in Regeneration Interval on the right.

If "YES" was chosen, then the specific days of the week to regenerate will be selected as follows:

The display will show "dAY" for two seconds followed by "SUN N". The "regen" key toggles the days of the week and the "+" and "-" keys toggle "Y or N".

Pressing the "STATUS" key saves and advances to the next step.

If any of the days were set to "yes", the display will show "SETDAY" followed by "SUN". This selects the current day of the week. The "+" or "-" key toggles through the days of the week and pressing the "STATUS" key saves the setting and advances to the next programming step.

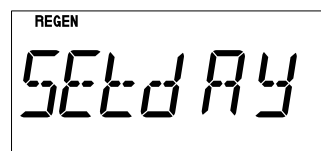
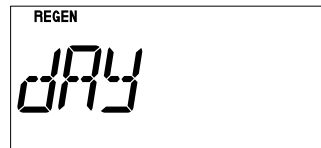
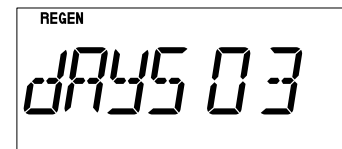
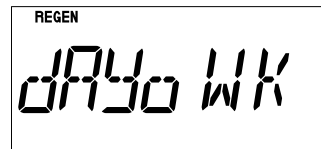



Programming (cont.)

If ALL of the days were set to "no", then specific day of week regens will be canceled and will appear as shown in Regeneration Interval above, and the interval will be set in number of days. Pressing the "STATUS" key saves the setting and advances to the next programming step.

Note: *If any day of the week is set to "yes", the regeneration interval in number of days ("Days 03") will no longer appear when going through the programming menu at a later time. To go back from specific day of week regeneration to interval in number of days, choose "NO" at "dAYoWK".*

- 8. Programming Mode Timeout** - If no key activity occurs for a period of 180 seconds (3 minutes) while in programming mode, the mode will time out, exit the programming mode and return to time of day display. Any setting that wasn't saved by pressing the 'status' key prior to the control timing out will revert back to the original value.



Statistic Functions

The statistical functions are reached by pressing the "Statistics" key. Repetitive presses of the "Statistics" key will cycle through the standard statistics mode until cycled back to time of day display.

Once either of the statistics menus is entered the information shown for each display is outlined below:

- **Time Clock** - This display will only show when in Time Clock mode (no meter attached). The display will alternate between 'Time' and 'Clock' every second until the 'statistics' key is pressed or until the function times out.

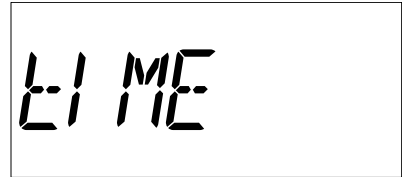



Following these simple precautions will help assure continued trouble-free service and keep your Culligan Water Conditioner looking like new for years.

- 1** Use only mild soap and warm water when cleaning the exterior of the conditioner. Never use harsh, abrasive cleaning compounds or those which contain acid, such as vinegar, bleach and similar products.
- 2 Important:** Protect your water conditioner and the entire drainline from freezing temperatures. **DANGER! If your unit should freeze, do not attempt to disassemble it. Call your Culligan Dealer.**
- 3 Important:** Culligan water filters are sold for use on potable water, only. If at any time the water becomes contaminated, such as during a "boil water" situation, the operation of the water filter should be discontinued until it is verified that the water is again potable. To do this, push the red knob on the back of the water filter against the barrel of the bypass valve. Then, call your Culligan dealer to have your system sanitized before it is placed back into service.

Note: Following the manufacturer's instructions regarding operation, maintenance and replacement requirements, including replacement of filters if applicable, is essential for Culligan's products to perform as advertised.

- 4** Should service, adjustment or trouble-shooting information be needed which is not covered in the Use and Care Guide, call your Culligan Dealer.

If you have further questions, please call your local independently operated Culligan dealer. He or she will be glad to be of assistance to you. For your nearest Culligan dealer, call (800) 285-5442.

Recommended Preventative Maintenance Inspection Schedule

The Culligan Gold Series water filter has been designed to provide a good, consistent service life. Routinely inspecting the system may help avoid potentially costly breakdowns related to circumstances outside of the control of the dealer and/or user. The filter is for problem water use and routine maintenance is required. Contact your local Culligan dealer to perform routine maintenance.

| Component | Suggested Inspection Frequency | Reason for Maintenance |
|--------------------------|---|---|
| Entire System | At Start-up, after infrequent use (idle for one week or more) or every 3 - 6 months if on a private water supply. | On private supplies, the appearance of off-tastes and odors, particularly if musty or "rotten egg" (caused by harmless sulfate-reducing bacteria) may indicate a need for the system to be sanitized. |
| Backwash Flow Controller | Every 12 months or every time service is performed on the system. | Build up of sediment, iron and/or other foreign materials (found in some water supplies but not necessarily all) could negatively affect system performance. Monitor item for normal or unexpected wear. |
| Media | As needed. | Cullneu Filter - As water passes through the Cullneu filter, the media slowly dissolves and neutralizes the water. The rate at which the Cullneu media dissolves depends on a number of factors such as temperature flow rate and pH. Add media when pH elevation no longer occurs. Cullar - Replace when taste odor or chlorine can no longer be removed. Filtr-Cleer - Media may need to be reconditioned or replaced depending on water characteristics. |

Care and Cleaning of Your Water Conditioner



Things to Check Before You Call For Service

If you unexpectedly experience changes in your water, make these simple checks before calling your Culligan dealer. One of the following conditions may be the reason for your interruption of service.

Important

If any of the following conditions is found, the water conditioner should be manually recharged according to instructions on page 6 after you have corrected the problem.

Power Supply

Check your power supply cord. Is it plugged fully into the electric outlet? Be certain that the outlet is not controlled by a wall switch which has been turned off. Plug in the transformer then reset conditioner to proper time of day.

Blown Fuse

Check the house fuse or circuit breaker panel. Replace a blown-out fuse or reset an open circuit breaker.

Power Failure

Any interruption in your power supply or time changes - such as daylight savings - will disrupt your conditioner's recharge schedule by causing the timer to run off-schedule. Reset timer to proper time of day.

Bypass Valves

Check to see if they are in the proper position. Cul-Flo-Valv[®] Bypass, if used, should be in the "Push for Service" position. If hand valves are used, see that inlet and outlet valve are opened and that the bypass valve is closed.

No Water

If you aren't getting any water flow at all, make sure your water supply is working. Open a tap ahead of the conditioner (outside tap) to see if you have any water pressure. If you have water pressure, check the bypass valve. If it is in the Service position, put it into the bypass and call your Culligan dealer for service.

Increased Usage

Guests, family additions, new water-using appliances, etc., all will result in more water usage and will require more capacity from your conditioner. You can reprogram your recharging schedule by following the directions on pages 7 - 9. Call your Culligan dealer for advice and save a service call.



The Accusoft Plus microprocessor is equipped with an advanced error detection system. During all operating modes the softener's electronics are performing self-diagnostics to ensure that the unit is operating correctly. There may be times, however, when something may occur that could cause the unit to improperly operate. In those instances the microprocessor will identify the exact problem and alert the user with an error code. Shown below is a description of the error codes.

Error Codes

| Display | Alert Code Description | Mode of Detection | Comments |
|--------------|--------------------------|--|--|
| <i>ERR 1</i> | Motor Failure to Start | If the valve fails to reach the desired state within 70 seconds of driving the motor. The control will attempt to start the motor 3 times for 70 seconds each time with a 60 second off period between each attempt. | Press and hold 'Program' key for 10 seconds. |
| <i>ERR 2</i> | Motor Failure to Stop | If the control detects changes in the Cam inputs when the motor is not supposed to be turning. | Press and hold 'Program' key for 10 seconds. |
| <i>ERR 3</i> | Incorrect Cycle Position | The control expects to be in a different position than that indicated by the Cam switch closures. | Press and hold 'Program' key for 10 seconds. |

To reset an error, press and hold for 10 seconds the status button. The unit will beep and check to see if indeed the error has been fixed. If the error was not fixed, the board will re-display the error code. If the error code does not reset please contact your local Culligan Dealer. For additional troubleshooting or service needs, please contact your local Culligan Dealer.



When and How to Bypass Your Water Conditioner

Normally, all water except outside lines passes through the water conditioner. There are times when the water conditioner should be bypassed, using the push-button Cul-Flo-Valv® Bypass, or a 3-way bypass valve. You should bypass:

1. If lines to outside faucets do not bypass the water conditioner, and you do not want to waste soft water on lawn sprinkling or other outside uses.
2. If you are going away on vacation and want to save salt by not having the unit recharge while you're away.

Bypass Valve

In the back of Culligan water conditioners is a push-button Cul-Flo-Valv® Bypass. To bypass unit, simply turn the blue knob clockwise. To return to soft water service, reverse the procedure - turn the blue knob counter-clockwise.

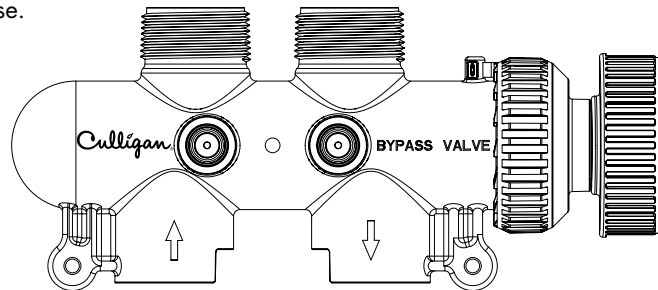

Bypassed

To BYPASS, turn the blue knob clockwise (see directional arrow on end of knob) until the knob stops as shown.

DO NOT OVERTIGHTEN!

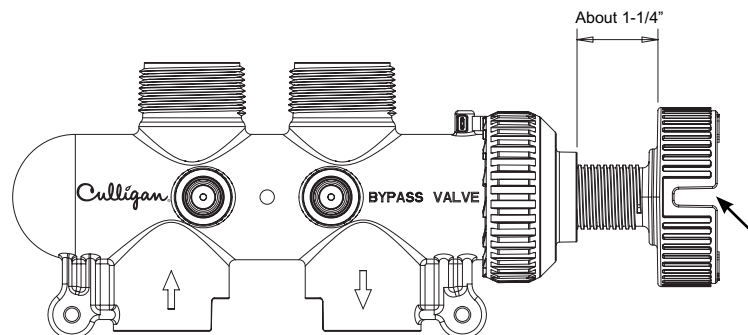
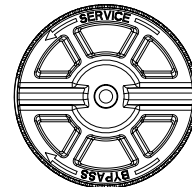

A screwdriver shank may be used in the slot (arrow) as a lever for extra turning force if needed

Soft Water

To return to SERVICE, turn the blue knob counter-clockwise (see directional arrow on end of knob) until the knob stops as shown.

DO NOT OVERTIGHTEN!



Performance Data Sheet

Culligan knows the more informed you are about your water treatment systems, the more confident you will be about its performance. It's because of this and more than seventy years of commitment to customer satisfaction that Culligan is providing this Performance Data Sheet to its customers.

Important Note: Read this Performance Data Sheet and compare the capabilities of this unit with your actual water treatment needs. It is recommended that before purchasing a water treatment unit, you have your water supply tested to determine your actual water treatment needs.

Manufacturer: Culligan International Company

9399 West Higgins Road, Suite 1100, Rosemont, IL 60018 USA
 (847) 430-2800
 www.culligan.com

Product: Culligan Gold Series 9" Cullar & 10" Cullar Filter

Testing Conditions & Results:

Capacity: 120,000 gallons for the 9" Filter Pressure: 60 psi
 180,000 gallons for the 10" Filter Temperature: 63°-73°F (17°-23°C)
 pH: 7.6

Service Flow: 4.0 gpm @ 3.0 psi for the 9" Filter
 6.0 gpm @ 6.0 psi for the 10" Filter

Operating Conditions:

Operating Temperature Range: 33 - 120°F (1 - 50°C)
 Water Pressure Range: 20 - 120 psi (140 - 830 kPa)
 Water Pressure Range (Canada): 20-90 psi (140-620 kPa)
 Electrical Characteristics: 24V/50-60 Hz, 45 Watts



Substance Reduction

While testing was performed under standard laboratory conditions, actual performance may vary.

| Model | Substance | USEPA SDWA MCL | Average % Reduction | Min. % Reduction | Avg Test Influent Concentration Level | Avg Test Effluent Concentration Level |
|------------|-----------------------|----------------|---------------------|------------------|---------------------------------------|---------------------------------------|
| 9" Cullar | Chlorine Taste & Odor | N/A | 99 | 99 | 1.92 mg/L | 0.02 mg/L |
| 10" Cullar | Chlorine Taste & Odor | N/A | 98.9 | 98.6 | 2.11 mg/L | 0.02 mg/L |

The Culligan Gold Series Cullar filter has been tested and certified by WQA against WQA S-200 and NSF/ANSI 42 for the effective aesthetic reduction of chlorine taste and odor up to 120,000 gallons for the 9" filter and 180,000 gallons for the 10" filter. The concentration of the indicated substances in water entering the system was reduced to a concentration less than or equal to the permissible limit for water leaving the system, as specified in NSF/ANSI 42.

Performance Indicator: If water flow decreases or a Noticeable taste change occurs, the filter should be backwashed. If conditions do not improve, contact your local Culligan Man®. He can determine if your filter requires servicing. Do not use with water that is microbiologically unsafe or of unknown quality without adequate disinfection before or after the system. Refer to the specifications and warranty sections of this owners guide for more specific product information.

To avoid contamination from improper handling and installation, your system should only be installed and serviced by your Culligan Man. Performance will vary based on local water conditions. The substances reduced by this product are not necessarily in your water.



Performance Data Sheet (cont.)

Culligan knows the more informed you are about your water treatment systems, the more confident you will be about its performance. It's because of this and more than seventy years of commitment to customer satisfaction that Culligan is providing this Performance Data Sheet to its customers.

Important Note: Read this Performance Data Sheet and compare the capabilities of this unit with your actual water treatment needs. It is recommended that before purchasing a water treatment unit, you have your water supply tested to determine your actual water treatment needs.

Manufacturer: Culligan International Company

9399 West Higgins Road, Suite 1100, Rosemont, IL 60018 USA
 (847) 430-2800
 www.culligan.com

Product: Culligan Gold Series 9" Cullneu & 10" Cullneu Filter

Testing Conditions & Results:

| | | | |
|-----------|-----------------------------------|--------------|---------------------|
| Capacity: | 14,500 gallons for the 9" Filter | Pressure: | 60 psi |
| | 21,750 gallons for the 10" Filter | Temperature: | 63°-73°F (17°-23°C) |
| pH: | 4.9-5.5 | | |

Service Flow: 4.0 gpm @ 2.0 psi for the 9" Filter
 6.0 gpm @ 5.0 psi for the 10" Filter

Operating Conditions:

Operating Temperature Range: 33 - 120°F (1 - 50°C)
 Water Pressure Range: 20 - 120 psi (140 - 830 kPa)
 Water Pressure Range (Canada): 20-90 psi (140-620 kPa)
 Electrical Characteristics: 24V/50-60 Hz, 45 Watts



Substance Reduction

While testing was performed under standard laboratory conditions, actual performance may vary.

| Model | Substance | USEPA SDWA MCL | Average % Reduction | Min. Effluent Reduction | Avg Test Influent Concentration Level | Avg Test Effluent Concentration Level |
|------------|-----------|----------------|---------------------|-------------------------|---------------------------------------|---------------------------------------|
| 9" Cullneu | pH | 6.5 - 8.5 | N/A | 6.6 | 3.9 | 7.0 |
| 10" Culleu | pH | 6.5 - 8.5 | N/A | N/A | 4.6 | ≥7.1 |

The Culligan Gold Series Cullneu filter has been tested and certified by WQA against WQA S-200 and NSF/ANSI 42 for neutralization up to 14,500 gallons for the 9" filters and 21,750 gallons for the 10" filters as verified and substantiated by test data. The concentration of the indicated substances in water entering the system was reduced to a concentration less than or equal to the permissible limit for water leaving the system, as specified in NSF/ANSI 42.

Performance Indicator: If water flow decreases or a Noticeable taste change occurs, the filter should be backwashed. If conditions do not improve, contact your local Culligan Man®. He can determine if your filter requires servicing. Do not use with water that is microbiologically unsafe or of unknown quality without adequate disinfection before or after the system. Refer to the specifications and warranty sections of this owners guide for more specific product information.

To avoid contamination from improper handling and installation, your system should only be installed and serviced by your Culligan Man. Performance will vary based on local water conditions. The substances reduced by this product are not necessarily in your water.



Performance Data Sheet (cont.)

Culligan knows the more informed you are about your water treatment systems, the more confident you will be about its performance. It's because of this and more than seventy years of commitment to customer satisfaction that Culligan is providing this Performance Data Sheet to its customers.

Important Note: Read this Performance Data Sheet and compare the capabilities of this unit with your actual water treatment needs. It is recommended that before purchasing a water treatment unit, you have your water supply tested to determine your actual water treatment needs.

Manufacturer: Culligan International Company

9399 West Higgins Road, Suite 1100, Rosemont, IL 60018 USA
 (847) 430-2800
 www.culligan.com

Product: Culligan Gold Series 9" Filtr-Cleer & 10" Filtr-Cleer Filter

Testing Conditions & Results:

Service Flow: 9.0 gpm @ 8.0 psi for the 9" Filter Pressure: 60 psi
 12.0 gpm @ 15.0 psi for the 10" Filter Temperature: 76°-78°F (24°-25°C)
 pH: 4.9-5.5

Operating Conditions:

Operating Temperature Range: 33 - 120°F (1 - 50°C)
 Water Pressure Range: 20 - 120 psi (140 - 830 kPa)
 Water Pressure Range (Canada): 20-90 psi (140-620 kPa)
 Electrical Characteristics: 24V/50-60 Hz, 45 Watts



Substance Reduction

While testing was performed under standard laboratory conditions, actual performance may vary.

| Model | Substance | Avg Test Effluent Challenge Concentration | Reduction Required | Average % Reduction | Min. % Reduction |
|----------------|---|---|--------------------|---------------------|------------------|
| 9" Filtr-Cleer | Class V Particulate ≥30 um to <50 um | 9 #/mL | ≥85% | 99.2 | 97.5 |

The Culligan Gold Series Filter-Cleer 9" filter has been tested and certified by WQA against WQA S-200 and NSF/ANSI 42 for Class V (30um to < 50um) particulate reduction as verified and substantiated by test data. The Culligan Gold series Filter-Cleer 10" filter has not been tested or certified by WQA. The concentration of the indicated substances in water entering the system was reduced to a concentration less than or equal to the permissible limit for water leaving the system, as specified in NSF/ANSI 42.

Performance Indicator: If water flow decreases or a noticeable taste change occurs, the filter should be backwashed. If conditions do not improve, contact your local Culligan Man®. He can determine if your filter requires servicing. Do not use with water that is microbiologically unsafe or of unknown quality without adequate disinfection before or after the system. Refer to the specifications and warranty sections of this owners guide for more specific product information.

To avoid contamination from improper handling and installation, your system should only be installed and serviced by your Culligan Man. Performance will vary based on local water conditions. The substances reduced by this product are not necessarily in your water.



Records and Data

Important Data on Your Water Filter

It is advisable to have the salesperson or installer fill in the information below for your future reference. If this has not been done, please ask for it, as it is necessary if you contact your dealer.

Identification

Model Name _____ Catalog No. _____

Control Model No. _____ Control Serial No. _____

Date of Installation _____ Tank Serial No. _____

Settings

Time of Recharge: _____ a.m. / _____ p.m.

Regeneration Interval _____ days

Number of people in household _____

Tank Size _____ inches

Water Analysis

Total Hardness _____ (gpg)

Total Iron _____ (ppm)

pH (acidity) _____

Other _____



Culligan Gold Series® Automatic Water Filters

You have just purchased one of the finest water conditioners made. As an expression of our confidence in Culligan International Company products, your water conditioner is warranted to the original end-user, when installed in accordance with Culligan specifications, against defects in material and workmanship from the date of original installation, as follows:

For a period of ONE YEAR

For a period of FIVE YEARS

For a period of TEN YEARS

**For the LIFETIME of the
original consumer purchaser**

The entire conditioner

Soft-Minder® meter, if so equipped.

**The AccuSoft® Plus circuit board,
The control valve body,
excluding internal parts**

The Quadra-Hull® conditioner tank

If a part described above is found defective within the specified period, you should notify your independently operated Culligan dealer and arrange a time during normal business hours for the dealer to inspect the water conditioner on your premises. Any part found defective within the terms of this warranty will be repaired or replaced by the dealer. You pay only freight from our factory and local dealer charges.

We are not responsible for damage caused by accident, fire, flood, freezing, Act of God, misuse, misapplication, neglect, oxidizing agents (such as chlorine, ozone, chloramines and other related components), alteration, installation or operation contrary to our printed instructions, or by the use of accessories or components which do not meet Culligan specifications, is not covered by this warranty. Refer to the specifications section in the Installation and Operating manual for application parameters.

Our product performance specifications are furnished with each water conditioning unit. **To the extent permitted by law, Culligan disclaims all implied warranties, including without limitation warranties of merchantability and fitness for particular purpose; to the extent required by law, any such implied warranties are limited in duration to the one-year period specified above for the entire conditioner.** As a manufacturer, we do not know the characteristics of your water supply or the purpose for which you are purchasing a water conditioner. The quality of water supplies may vary seasonally or over a period of time, and your water usage rate may vary as well. Water characteristics can also differ considerably if your water conditioner is moved to a new location. For these reasons, we assume no liability for the determination of the proper equipment necessary to meet your requirements, and we do not authorize others to assume such obligations for us. Further, we assume no liability and extend no warranties, express or implied, for the use of this product with a non-potable water source. **Our obligations under this warranty are limited to the repair or replacement of the failed parts of the water conditioner, and we assume no liability whatsoever for direct, indirect, incidental, consequential, special, general, or other damages.**

Some states do not allow the exclusion of implied warranties or limitations on how long an implied warranty lasts, so the above limitation may not apply to you. Similarly, some states do not allow the exclusion of incidental or consequential damages, so the above limitation or exclusion may not apply to you. This warranty gives you specific legal rights, and you may also have other rights which vary from state to state. Consult your telephone directory for your local independently operated Culligan dealer, or write Culligan International Company for warranty and service information.

Culligan International Company

9399 West Higgins Road, Suite 1100, Rosemont, IL 60018 USA

(847) 430-2800

www.culligan.com

Culligan Limited Warranty



With Culligan You Get More Than a Quality Product

You Get Your Water Expert, The Culligan Man

We're here to provide you with fast, dependable service, making sure any problems you have are taken care of. The Culligan Man has been around for over seventy years, delivering quality products and dependable service all along. That's why people say "Hey, Culligan Man!®" Because we're the water experts. And that's who you want taking care of your water.

The Culligan Promise

At Culligan, we understand that a water quality improvement system is an investment in your family's well-being. That's why our 1,350 independently operated dealers worldwide don't just sell products; they sell water quality you can count on. We stand behind our products with written limited warranties and our unequalled Culligan service. No matter where you live, you can depend on Culligan expertise to work for you – today and tomorrow.